

CCS Technical Documentation

RH-21 Series Transceivers

Service Tools

Contents

	Page No
Service Tools.....	5
3520	5
Flashing and Testing Setups	11
FPS-8 Flash Prommer for Heavy Flash	11
FPS-8C Flash Prommer for Heavy Parallel Flash	11
User Instructions	12
FLA-39	12
MJF-23	14

Service Tools

3520

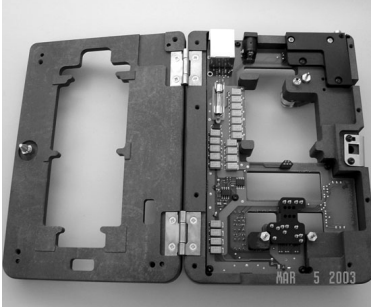

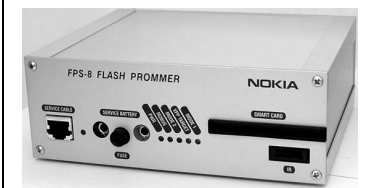
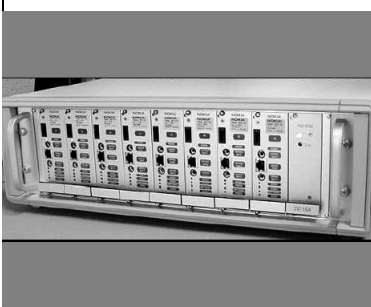
Photo	Code	Service Tool	Code	Description
	MJ-8	Module Jig	0770522	This jig allows phone PWB-level service and troubleshooting. Electric currents should be protected against over-voltage and over-current.
	FLS-4S	POS Flash Adapter	0080543	The Point of Sale (POS) flash is a low-cost software upgrade tool. This requires the XCS-1 cable and ACP-8U for operation.
	FPS-8	Flash Prommer	0080321	The Flash Prommer FPS-8 is used for flash.
	FPS-8C	Heavy Flash Prommer	0080396	The Heavy Flash Prommer FPS-8C is used for heavy parallel flashing.



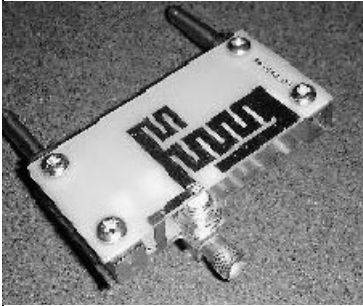

Photo	Code	Service Tool	Code	Description
	JBV-1	Docking Station	0770298	The Docking Station and the Docking Station Adapter (MJF-23) are needed for Mbus, Fbus, RF, and audio connections. This setup allows connection between flash prommers. When the audio box is connected, it has to be connected to the phone's audio connector.
	MJF-23	Docking Station Adapter	0770489	The Docking Station can be powered by FPS-8 or external power supply. <i>NOTE: SEE USER INSTRUCTIONS FOR MJF-23 ON PAGE 14.</i>
	CPL-1	Coupler	0770287	The coupler has been developed for antenna go/no go testing.
	JBA-8	Audio Box	0770320	The Audio Box is needed for audio connections. The box must support DCT4 Janette audios. JBA-8 provides an interconnection between the phone's system connector (XEAR, XMIC) through a fixed audio cable and audio tester with a BNC-BNC coax. Connection to a PC can be made with the service battery, through a DAU-9 cable.


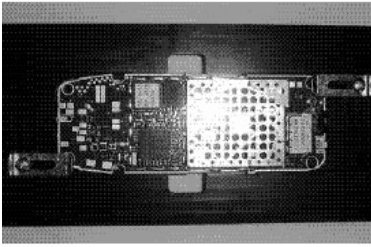


Photo	Code	Service Tool	Code	Description
	FLA-39	Flash Adapter	0770490	FLA-39 allows a continuous maximum power supply for the phone from an external power supply, the ACP-8. <i>NOTE: SEE USER INSTRUCTIONS FOR FLA-39 ON PAGE 12.</i> <i>Note: FLA-39 is not to be used for handset testing; it is only designed for flashing.</i>
	RJ-15	Soldering Jig	0770611	RJ-15 is used to hold the PWB during repair and troubleshooting.
	AXP-8	Printer Cable	073F000	The Parallel Printer Cable connects the parallel connector of the PC and the parallel input of the FPS-8.
	AXS-4	D9-D9 Cable	0730090	The AXS-4 D9-D9 service cable is used to connect two 9-pin connectors (e.g., between PC and FPS-8). AXS-4 length is 2 meters
	ADS-3	Audio Cable	0730197	The audio cable connects to the audio box JBA-6.

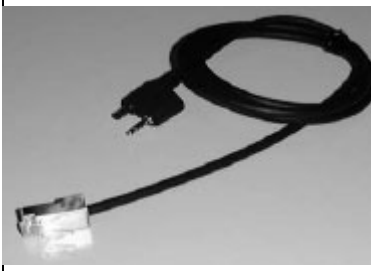
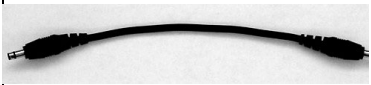



Photo	Code	Service Tool	Code	Description
	ADS-4	Audio Cable	0730222	ADS-4 is the service cable between the phone and the service audio box.
	SCB-3	DC Cable	0730114	The DC Cable SCB-3 is used to connect the docking station to the charger connection (Vin) of the phone to conduct the charger calibration service procedure.
	DAU-9S	Mbus Cable	0730108	The Mbus Cable has a modular connector and is used with the service audio box JBA-4 or a modular T-adapter.
	PCS-1	Power Cable	0730012	The Power Cable PCS-1 is used to connect the service tools (JBV-1, MJF-23) to an external power supply.
	XRF-1	RF Cable	0730085	The XRF-1 cable connects a service tool and RF measurement equipment.





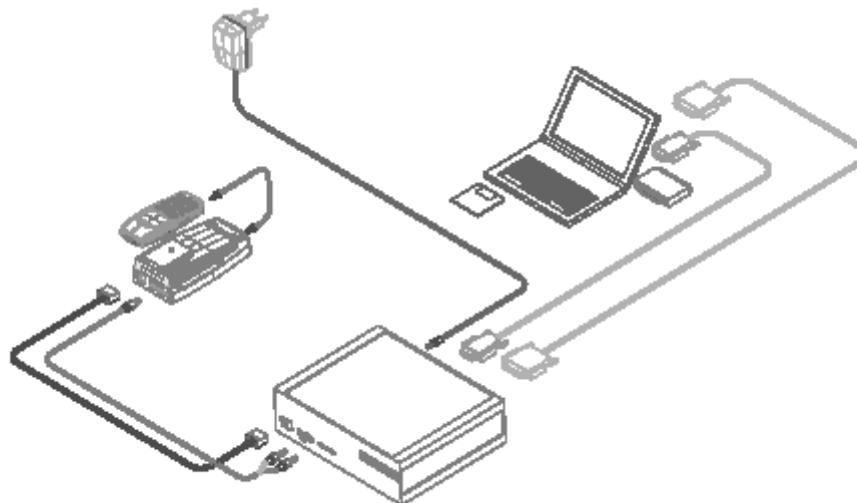
Photo	Code	Service Tool	Code	Description
	XCS-4	Mbus/Fbus Cable	0730178	The XCS-4 Service Cable is a modular cable for flashing DCT4 products.
	PKD-1	SW Security Device	0750018	<p>SW security device PKD-1 is hardware device that, when connected to the parallel (LPT) port of the PC, enables the use of the service software. Without the dongle present, it is not possible to use the service software. Printers or other peripheral devices can be connected to the PC through the dongle, if needed.</p> <p><i>Caution: Make sure that you have switched off the PC and the printer before making connections!</i></p> <p><i>Caution: Do not connect the PKD-1 to the serial port. You may damage your PKD-1!</i></p>
	SA-12 XRS-11	RF Probe Support RF Probe	0770623 0770562	<p>The RF Cable is used for connection to the RF output of the PWB.</p> <p>The XRS-11 Cable is used together with the SA-12 to ensure a good connection.</p>

Photo	Code	Service Tool	Code	Description
	<p>GAC-8/ GAC-9K</p>	<p>Adapter</p>	<p>0080834</p>	<p>The GAC-8/GAC-9K adapter is needed for proper RF connection. The adapter allows galvanic connections to assembled handset RF switches. The adapter permits the handset to be connected to RF measuring and test equipment during test and repair and can be used with covers on or off.</p> <p><i>NOTE: GAC-8 must be used with GAC-9k.</i></p>

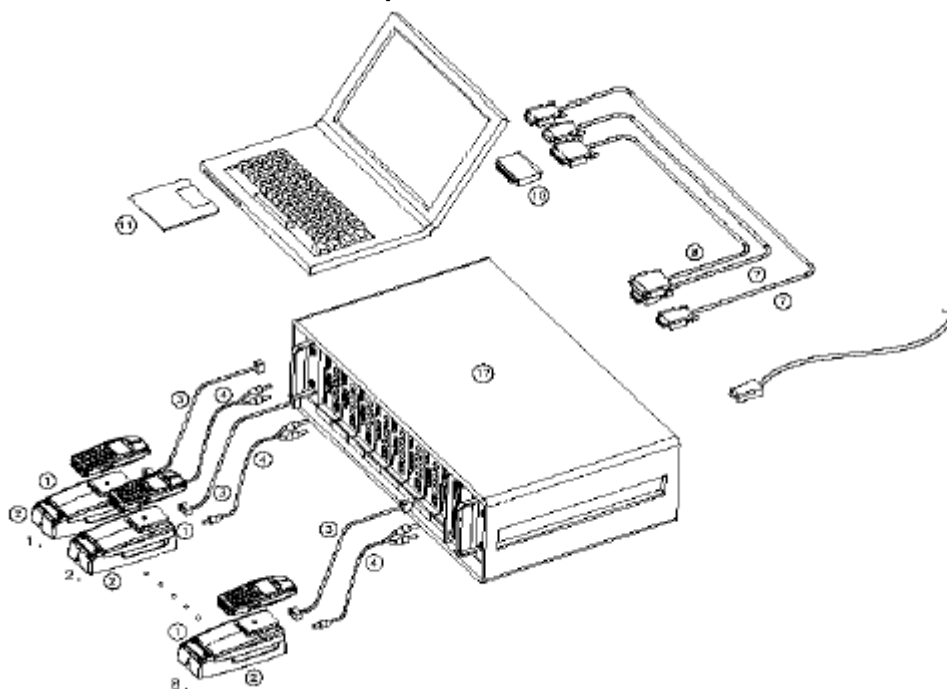
Flashing and Testing Setups

FPS-8 Flash Prommer for Heavy Flash



The FPS-8 flash prommer is used for heavy flashing. The sales pack product code is 0080321.

FPS-8C Flash Prommer for Heavy Parallel Flash



The FPS-8C flash prommer is used for heavy parallel flashing. The sales pack product code is 0080396.

User Instructions

FLA-39

Follow these instructions to avoid damage to the adapter or the phone.

Note: Using the adapter in any way other than described here may harm the important pins and connectors of the adapter. It cannot be used like the FLA-13 for 3520/3560 products.



- 1 Place the adapter in your left hand and the phone in your right hand.



- 2 Align the battery connector with the battery contacts of the adapter. Gently press the phone onto the adapter (see following picture).



- 3 Press the upper end of the handset down onto the adapter until the battery tabs of the D-cover catch the adapter.



To remove adapter, follow the inverse order of the installation in Steps 1 through 3.

MJF-23

Follow these instructions to avoid causing any damage to the adapter or the phone.

Note: Using the adapter in any other way may harm the important pins and connectors of the adapter. It cannot be used like the MJF-2 for 3520/3560 products.



- 1 Place the adapter in your left hand and the phone in your right hand.



- 2 Let the other edge of the phone down in place.



- 3 Press down the upper end of the phone with your finger until the battery latch locks the phone in place.



- 4 To remove the phone from the adapter, push the bottom connector end of the phone down to the hollow in the adapter. At the same time, push the upper end of the phone until it detaches from its place. Detach the phone in inverse order from installation.

